

# VERA

Fixed Veranda System  
Sabit Çatı Sistemi

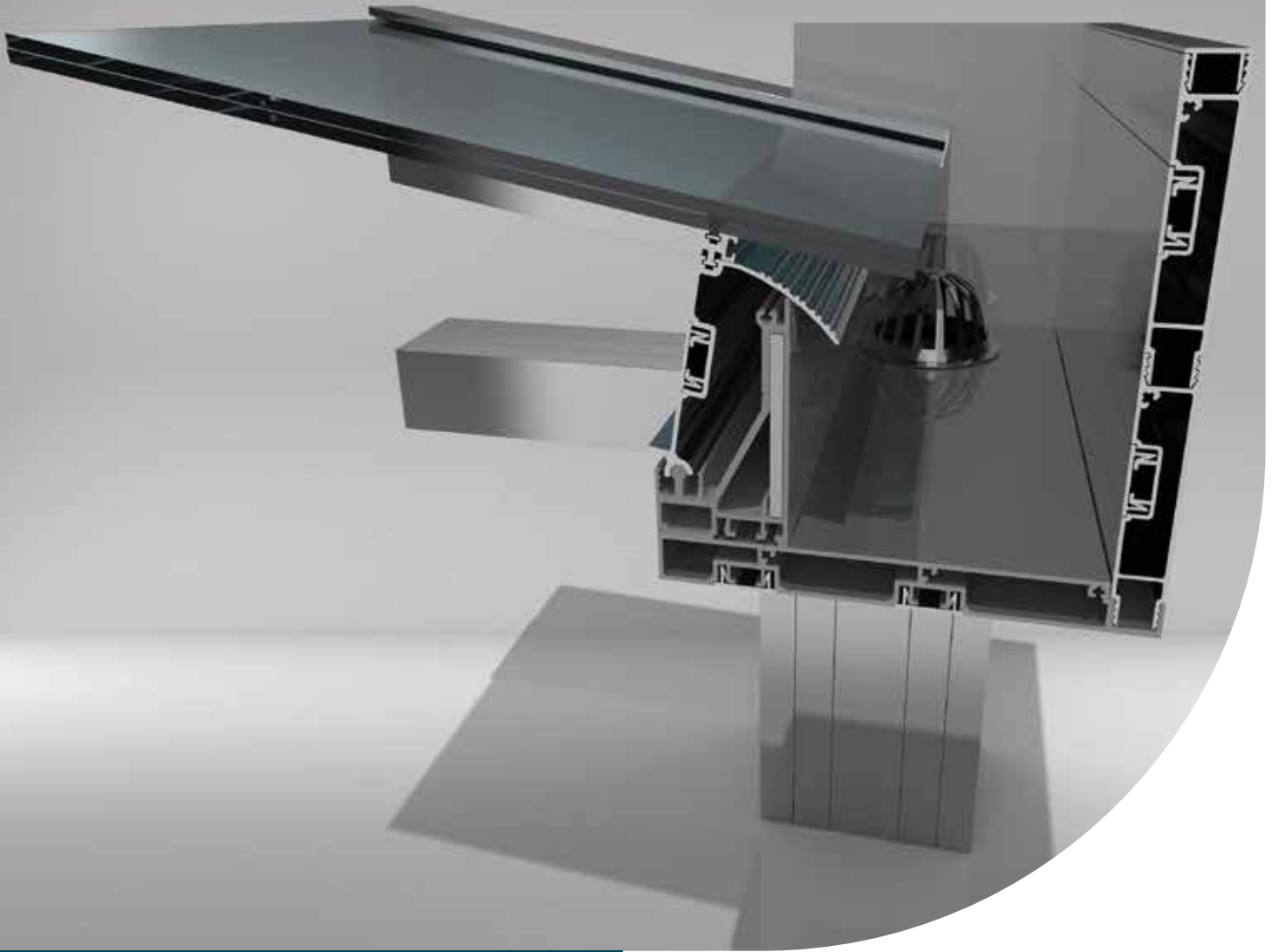

Technical Brochure | Teknik Broşür

[www.aluarc.com](http://www.aluarc.com)

**AluArc**<sup>®</sup>  
Aluminium Systems

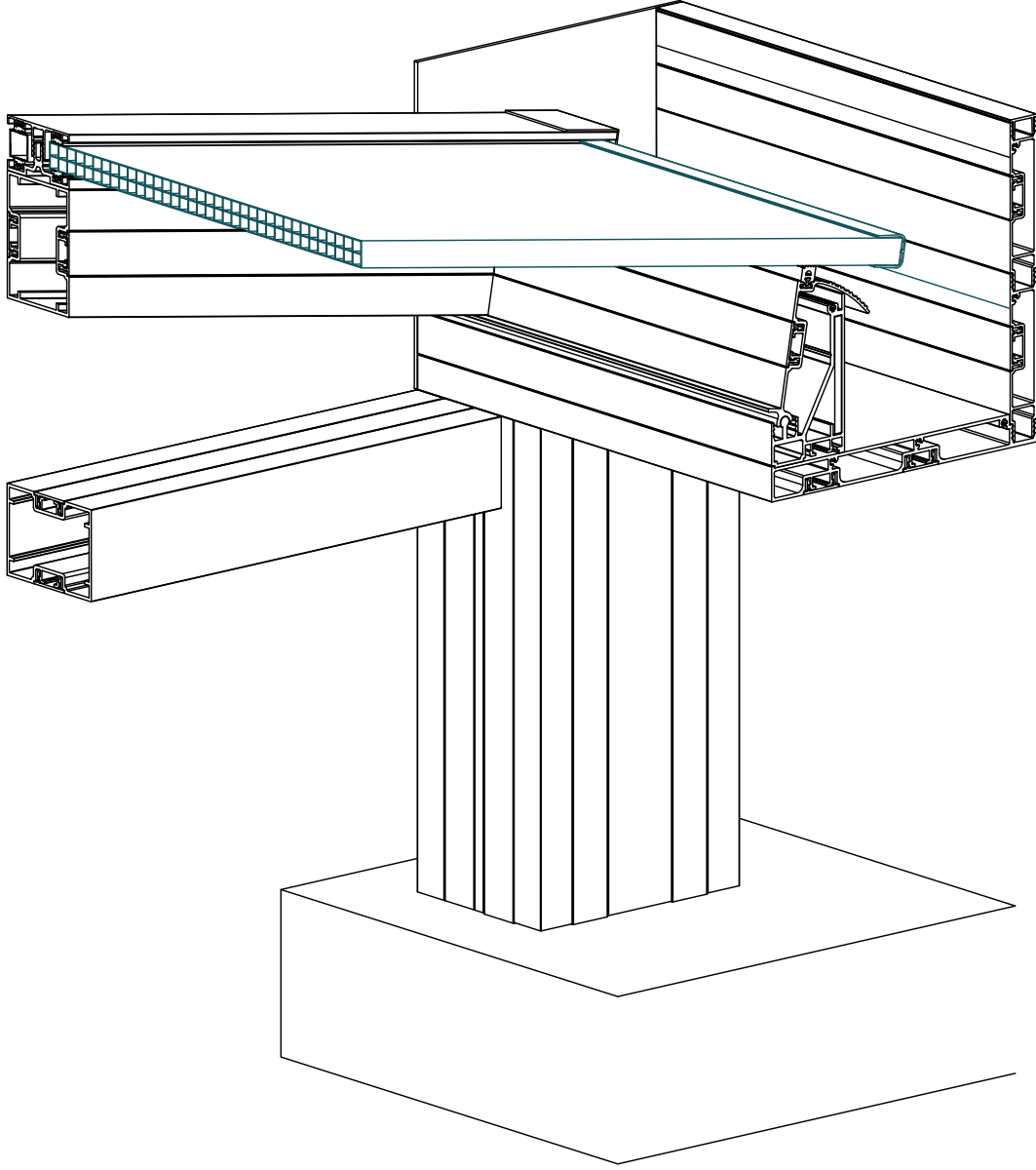

Fixed Veranda System / Sabit Çatı Sistemi

**VERA**



## VERA Technical Properties Roof / Çatı Teknik Özellikleri

Transom Profile / Yatay Profil	55 x 75 mm
Wall Thickness of Transom Profile / Yatay Profil Et Kalınlığı	2 mm
Mullion Profile / Dikme Profili	150x110 mm
Wall Thickness of Mullion Profile / Dikme Profili Et Kalınlığı	2,5 mm
Max. Glass Thickness / Maks. Cam Kalınlığı	10 - 38 mm

## VERA Performance Values / Performans Değerleri

Air Permability / Hava Geçirgenliği	EN 12152	A4 ( 600 pa )
Watertightnees / Su Sızdırmazlığı	EN 12154	R7 ( 600 pa )
Resistant to Windload / Rüzgar Yüğü Dayanımı	EN 13116	± 1.2 KN/m <sup>2</sup>

## VERA 55 Application Options / Uygulama Seçenekleri

Summer Garden Roof / Yaz Bahçesi Çatı	yes / evet
Double Roof / Çift Çatı	yes / evet
Reinforcement Profile / Çelik Profil	yes / evet
Wall Solutions / Duvar Çözümleri	yes / evet

# VERA Profiles / Profiller



Scale / Ölçü : 1/2

Fixed Veranda System / Sabit Çatı Sistemi

VERA

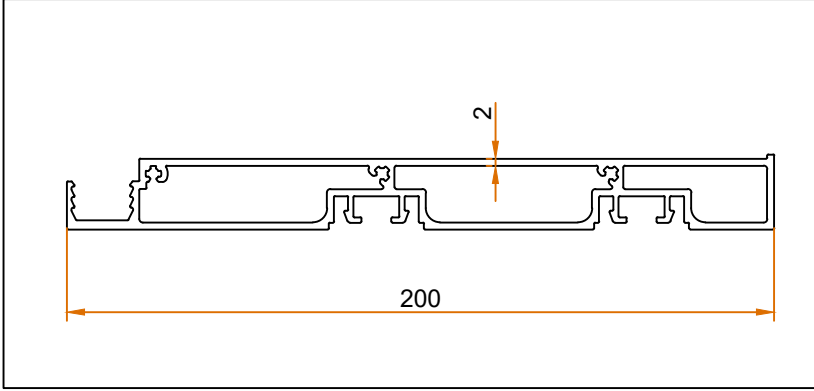

Profile Name / Profil İsmi :

Rain Water Gutter / Yağmur Suyu Oluğu

Code Nr. / Kod No.:

22 01 01 10

Weight / Ağırlık kg/m:

2.891

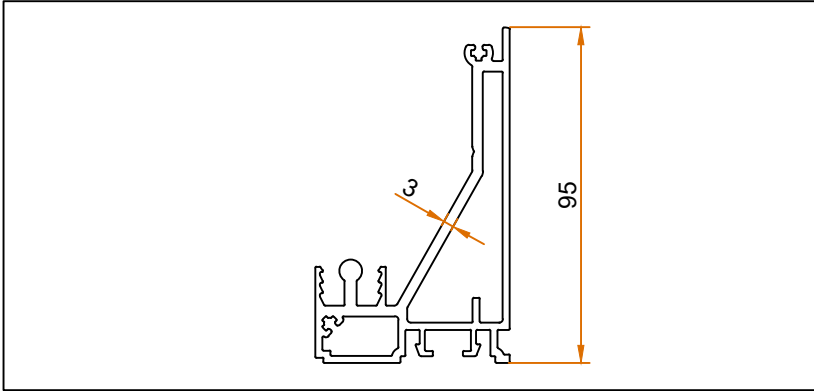

Profile Name / Profil İsmi :

Below Above Roof Connection / Alt Üst Tavan Bağlantısı

Code Nr. / Kod No.:

22 01 01 11

Weight / Ağırlık kg/m:

2.293

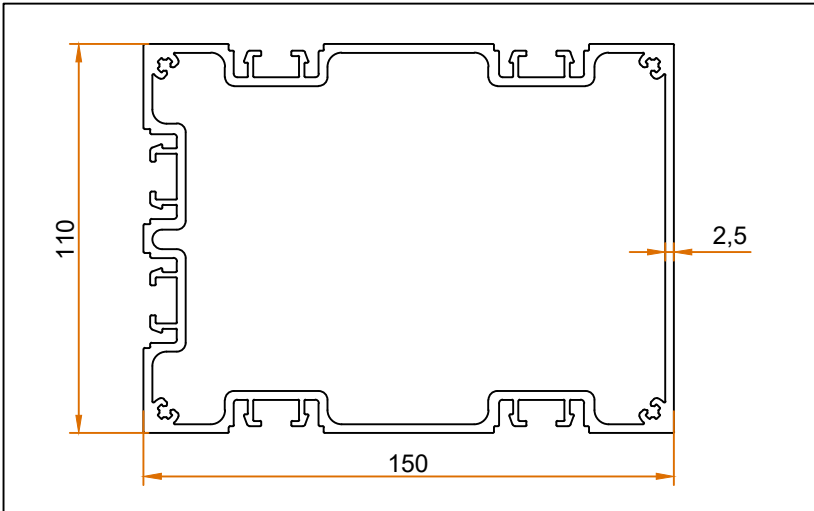

Profile Name / Profil İsmi :

Main Pillar / Ana Sütun

Code Nr. / Kod No.:

22 01 01 12

Weight / Ağırlık kg/m:

5.042

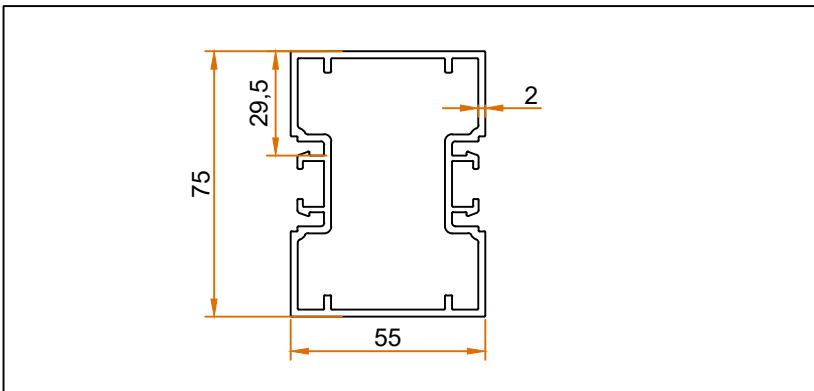

Profile Name / Profil İsmi :

Roof Rack / Çatı Taşıyıcı

Code Nr. / Kod No.:

22 01 01 13

Weight / Ağırlık kg/m:

1.835

# VERA Profiles / Profiller



Scale / Ölçü : 1/2

Fixed Veranda System / Sabit Çatı Sistemi

VERA

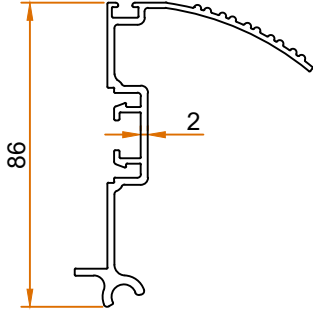

Profile Name / Profil İsmi :

Roof Rack Rocker / Hareketli Tavan Rafı

Code Nr. / Kod No.:

22 01 01 14

Weight / Ağırlık kg/m:

1.118

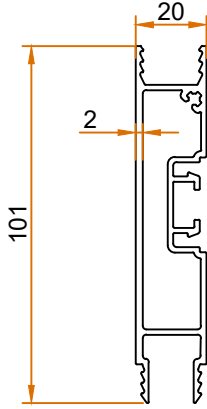

Profile Name / Profil İsmi :

Rain Water Gutter Adapter / Yağmur Oluk Adaptörü

Code Nr. / Kod No.:

22 01 01 15

Weight / Ağırlık kg/m:

1.306

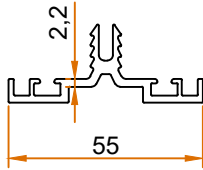

Profile Name / Profil İsmi :

Roof Rack Insert / Tavan Rafı Ek

Code Nr. / Kod No.:

21 01 01 10

Weight / Ağırlık kg/m:

0.625

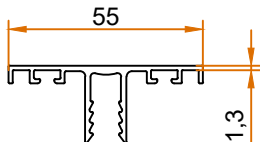

Profile Name / Profil İsmi :

Roof Rack Cover / Tavan Rafı Kapağı

Code Nr. / Kod No.:

21 01 01 11

Weight / Ağırlık kg/m:

0.498

# VERA Profiles / Profiller



Scale / Ölçü : 1/2

Fixed Veranda System / Sabit Çatı Sistemi

VERA

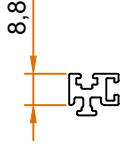

Profile Name / Profil İsmi :

Sash Connector / Kanat Konnektörü

Code Nr. / Kod No.:

22 01 01 23

Weight / Ağırlık kg/m:

0.223

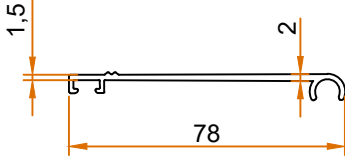

Profile Name / Profil İsmi :

Wall Connection 1 / Duvar Birleşim 1

Code Nr. / Kod No.:

22 01 01 24

Weight / Ağırlık kg/m:

0.437

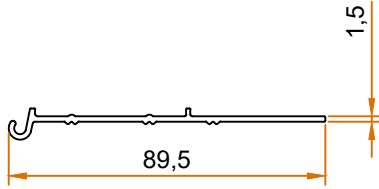

Profile Name / Profil İsmi :

Wall Connection 2 / Duvar Birleşim 2

Code Nr. / Kod No.:

22 01 01 25

Weight / Ağırlık kg/m:

0.432

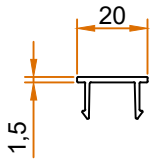

Profile Name / Profil İsmi :

Rain Water Gutter Cover / Yağmur Oluğu Kapağı

Code Nr. / Kod No.:

22 01 01 27

Weight / Ağırlık kg/m:

0.139

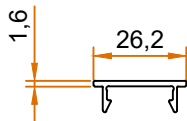

Profile Name / Profil İsmi :

Screw Channel Cover / Vida Kanalı Kapağı

Code Nr. / Kod No.:

22 01 01 26

Weight / Ağırlık kg/m:

0.152

# VERA Accessory / Aksesuar



Scale / Ölçü : 1/2

Fixed Veranda System / Sabit Çatı Sistemi

VERA

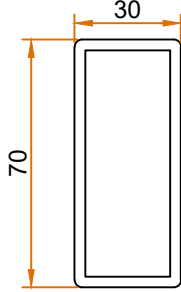

Profile Name / Profil İsmi :

Steel Profile El. St. Painted / Çelik Profil El. St. Boya

Code Nr. / Kod No.:

22 01 03 10

Weight / Ağırlık kg/m:

4.699

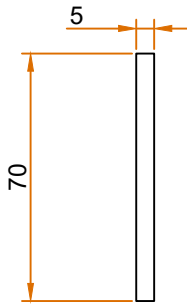

Profile Name / Profil İsmi :

Steel Profile El. St. Painted / Çelik Profil El. St. Boya

Code Nr. / Kod No.:

22 01 03 11

Weight / Ağırlık kg/m:

2.920

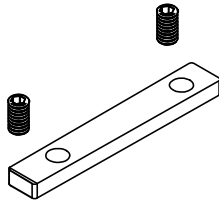

4 pieces DIN 914 screws M8x6mm  
4 adet DIN 914 setiskur M8x6mm

Profile Name / Profil İsmi :

Gutter Connection / Oluk Bağlantı

Code Nr. / Kod No.:

22 03 03 10

Material / Malzeme:

Steel Plate 5mm Galvanized / Çelik Sac 5mm Galvanize

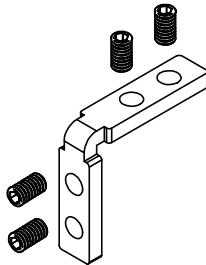

4 pieces DIN 914 screws M8x6mm  
4 adet DIN 914 setiskur M8x6mm

Profile Name / Profil İsmi :

Corner Connection / Köşe Bağlantı

Code Nr. / Kod No.:

22 03 03 11

Material / Malzeme:

Steel Plate 5mm Galvanized / Çelik Sac 5mm Galvanize

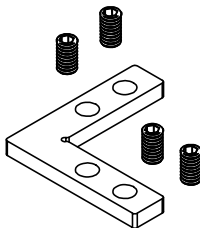

4 pieces DIN 914 screws M8x6mm  
4 adet DIN 914 setiskur M8x6mm

Profile Name / Profil İsmi :

Gutter Corner Connection / Oluk Köşe Bağlantı

Code Nr. / Kod No.:

22 03 03 12

Material / Malzeme:

Steel Plate 5mm Galvanized / Çelik Sac 5mm Galvanize

# VERA Accessory / Aksesuar



Scale / Ölçü : 1/2

Fixed Veranda System / Sabit Çatı Sistemi

VERA

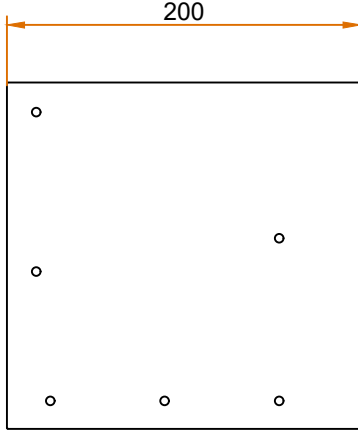

Profile Name / Profil İsmi :

Rain Water Gutter Cover / Yağmur Suyu Oluk Kapağı

Code Nr. / Kod No.:

22 02 03 10

Material / Malzeme:

Steel Plate 3mm El. St. Painted /  
Çelik Sac 3mm El. St. Boya

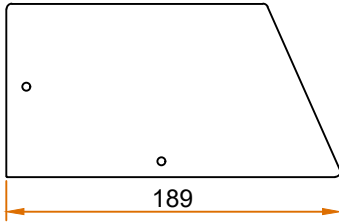

Profile Name / Profil İsmi :

Wall Connection Cover / Duvar Birleşim Kapağı

Code Nr. / Kod No.:

S 042

Material / Malzeme:

Steel Plate 3mm El. St. Painted /  
Çelik Sac 3mm El. St. Boya

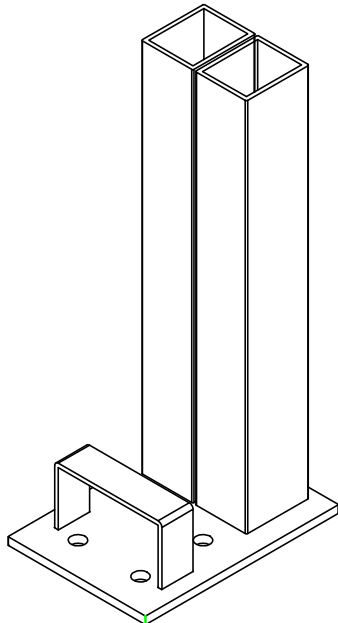

Profile Name / Profil İsmi :

Main Pillar Concrete Connection / Ana Ayak Beton Bağlantı

Code Nr. / Kod No.:

22 03 03 33

Material / Malzeme:

6 mm Steel Plate Welded and Galvanized /  
6 mm Çelik Sac Kaynak ve Galvanize



# VERA Accessory / Aksesuar



Scale / Ölçü : 1/2

Fixed Veranda System / Sabit Çatı Sistemi

VERA

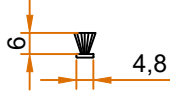

Profile Name / Profil İsmi :

Brush 4.8 / 600 / Kıl Fitol 4.8 / 600

Code Nr. / Kod No.:

22 05 07 11

Material / Malzeme:

PVC

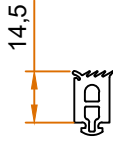

Profile Name / Profil İsmi :

Glass Gasket 14.5 mm / Cam Conta 14.5 mm

Code Nr. / Kod No.:

22 0 09 11

Material / Malzeme:

EPDM 167 g/m

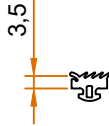

Profile Name / Profil İsmi :

Glass Gasket 3.5 mm / Cam Conta 3.5 mm

Code Nr. / Kod No.:

22 05 09 10

Material / Malzeme:

EPDM 60 g/m



Profile Name / Profil İsmi :

16 mm Multiwall Sheets Profile / 16 mm Polikarbon Profil

Code Nr. / Kod No.:

22 02 08 10

Material / Malzeme:

16 mm Polycarbon Profile / 16 mm Polikarbon Profil

# VERA Accessory / Aksesuar



Scale / Ölçü : 1/2

Fixed Veranda System / Sabit Çatı Sistemi

VERA

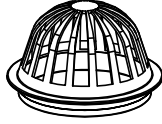

Profile Name / Profil İsmi :

Leaves Grid / Yaprak Tutucu

Code Nr. / Kod No.:

22 02 07 12

Material / Malzeme:

PVC

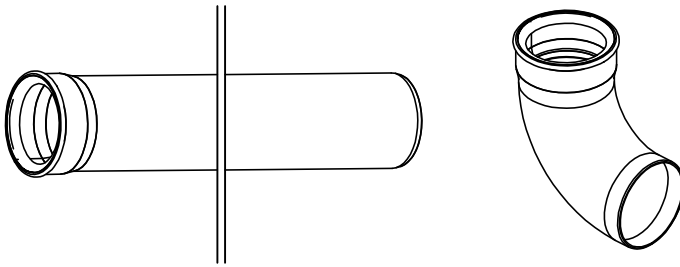

Profile Name / Profil İsmi :

Waste Pipe / Su Borusu 76x3000mm + 90 °

Code Nr. / Kod No.:

22 03 07 34

Material / Malzeme:

PVC

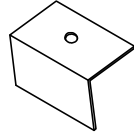

Profile Name / Profil İsmi :

Roof Rack Cover end Cup / Tavan Ray Kapağı Son Kapağı

Code Nr. / Kod No.:

22 02 0 11

Material / Malzeme:

40x1.2mm Alu Profile / Alü. Profil

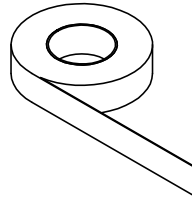

Profile Name / Profil İsmi :

16 mm Multiwall Sheets Band / 16 mm Polikarbon Bant

Code Nr. / Kod No.:

22 05 07 12

Material / Malzeme:

full / dolu

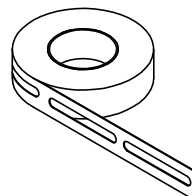

Profile Name / Profil İsmi :

16 mm Multiwall Sheets Band / 16 mm Polikarbon Bant

Code Nr. / Kod No.:

22 0 07 12

Material / Malzeme:

Perforated / Delikli

# VERA Accessory / Aksesuar



Scale / Ölçü : 1/2

Fixed Veranda System / Sabit Çatı Sistemi

VERA

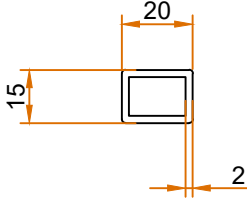

Profile Name / Profil İsmi :

PVC Profile / PVC Profil

Code Nr. / Kod No.:

22 01 07 10

Material / Malzeme:

PVC Black / PVC Siyah

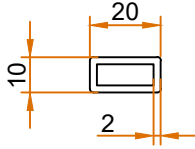

Profile Name / Profil İsmi :

PVC Profile / PVC Profil

Code Nr. / Kod No.:

22 01 07 11

Material / Malzeme:

PVC black / PVC siyah

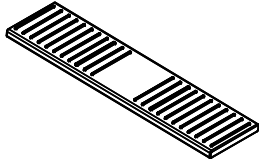

Profile Name / Profil İsmi :

Glass Spacer 2 mm / Cam Takoz 2 mm

Code Nr. / Kod No.:

22 02 07 14

Material / Malzeme:

PVC

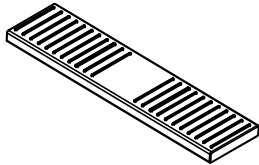

Profile Name / Profil İsmi :

Glass Spacer 4 mm / Cam Takoz 4 mm

Code Nr. / Kod No.:

22 02 07 15

Material / Malzeme:

PVC

# VERA Lower Section / Alt Bölüm

Scale / Ölçü : 1/2

Fixed Veranda System / Sabit Çatı Sistemi

VERA

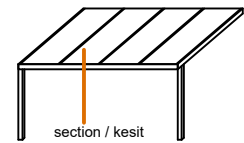
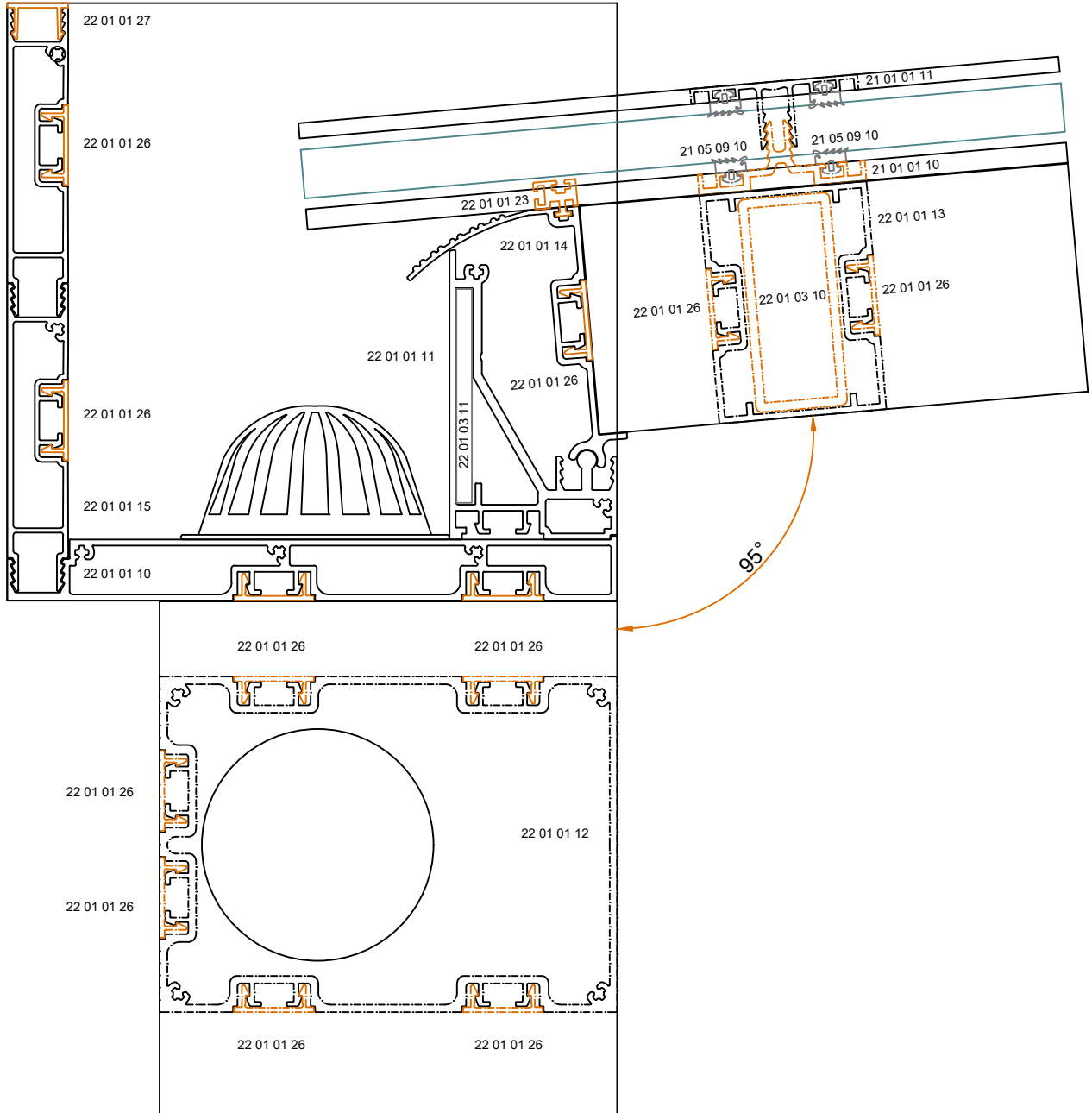

5 degree / 5 derece

# VERA Upper Section / Üst Bölüm



Scale / Ölçü : 1/2

Fixed Veranda System / Sabit Çatı Sistemi

VERA

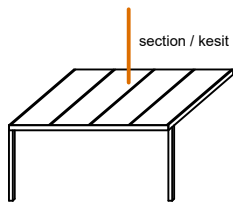
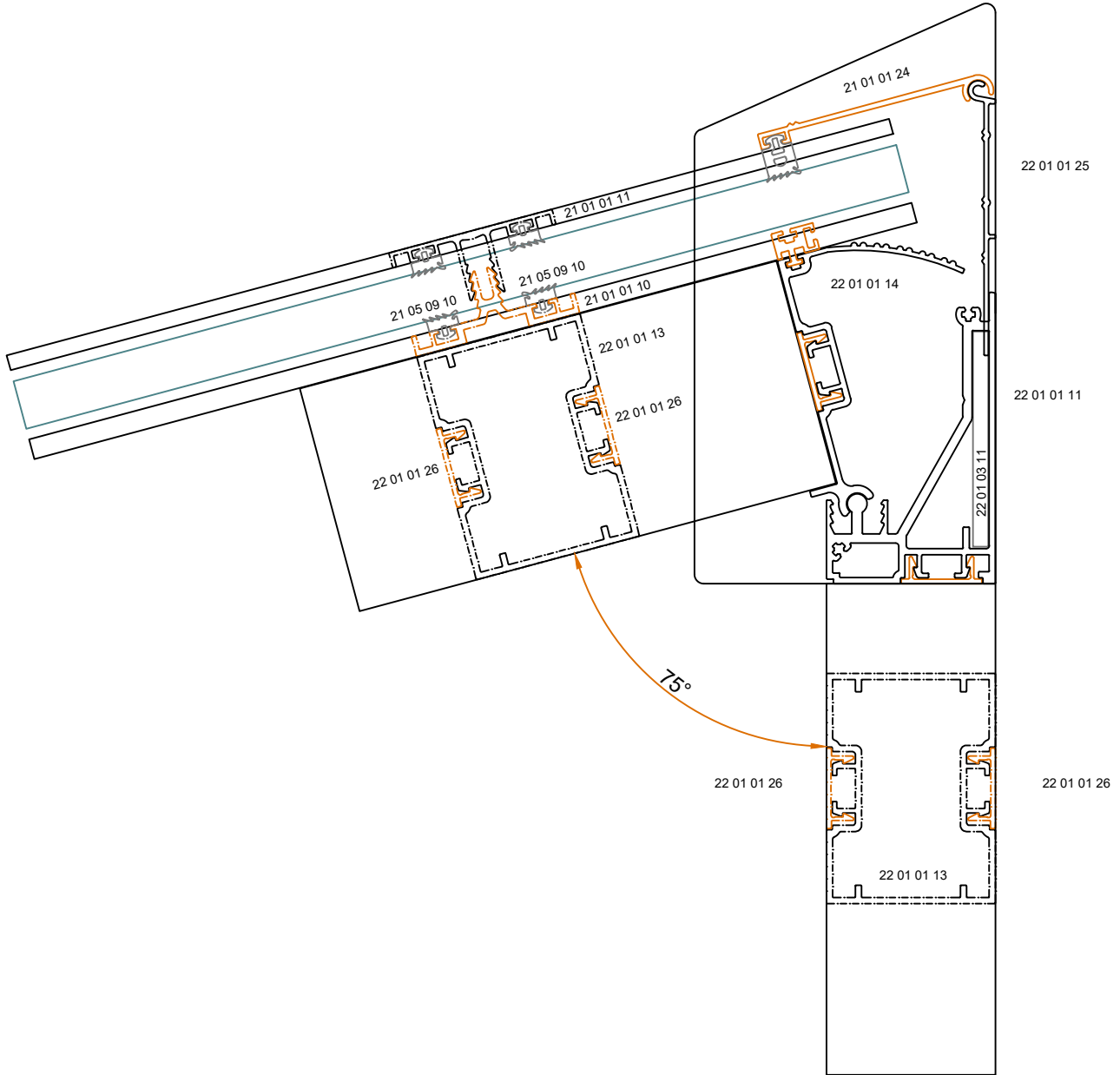

15 degree / 15 derece

# VERA Lower Section / Alt Bölüm

Scale / Ölçü : 1/2

Fixed Veranda System / Sabit Çatı Sistemi

VERA

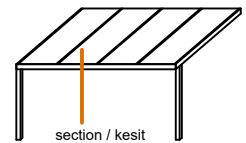
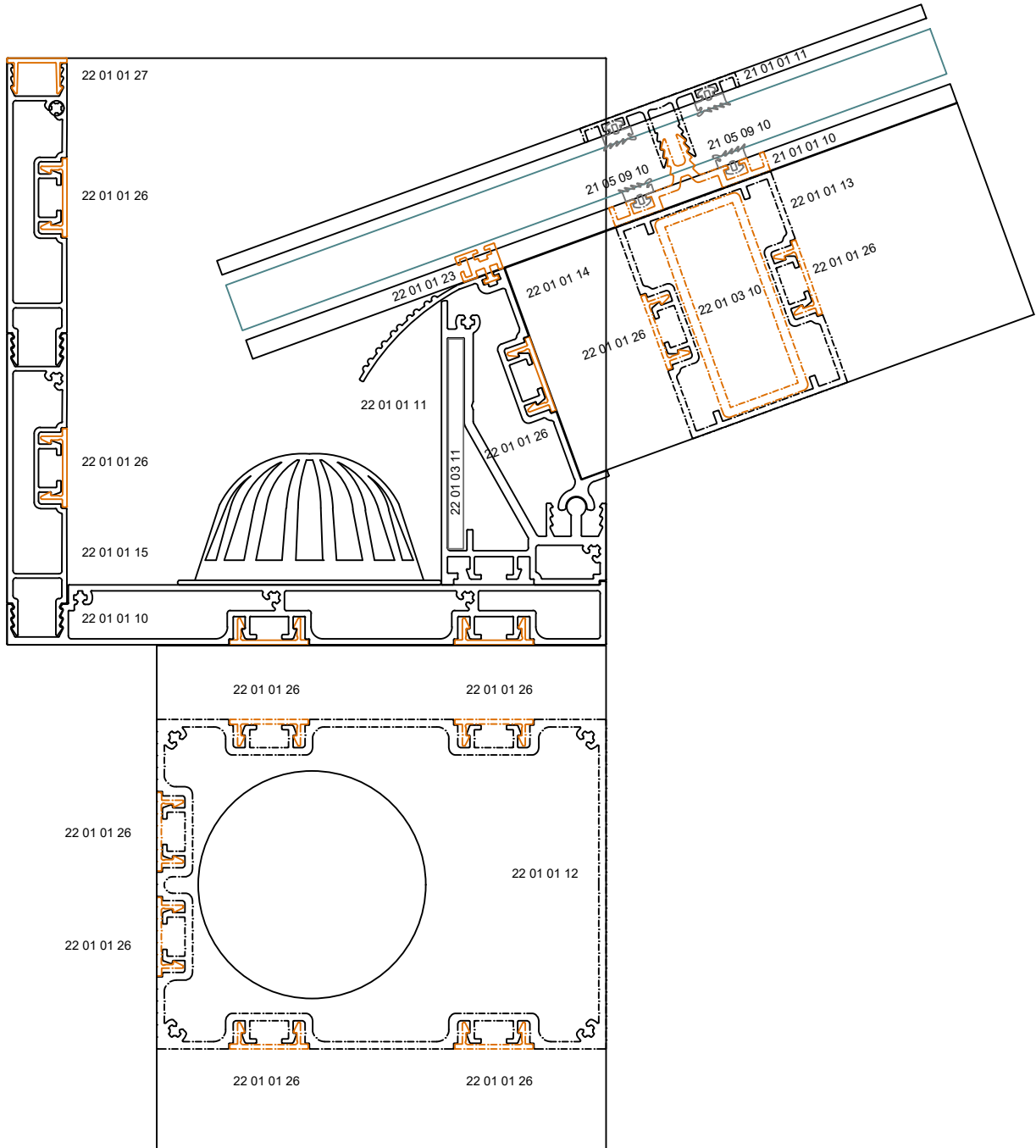

20 degree / 20 derece

# VERA Upper Section / Üst Bölüm



Scale / Ölçü : 1/2

Fixed Veranda System / Sabit Çatı Sistemi

## VERA

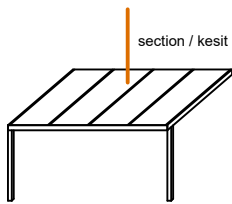
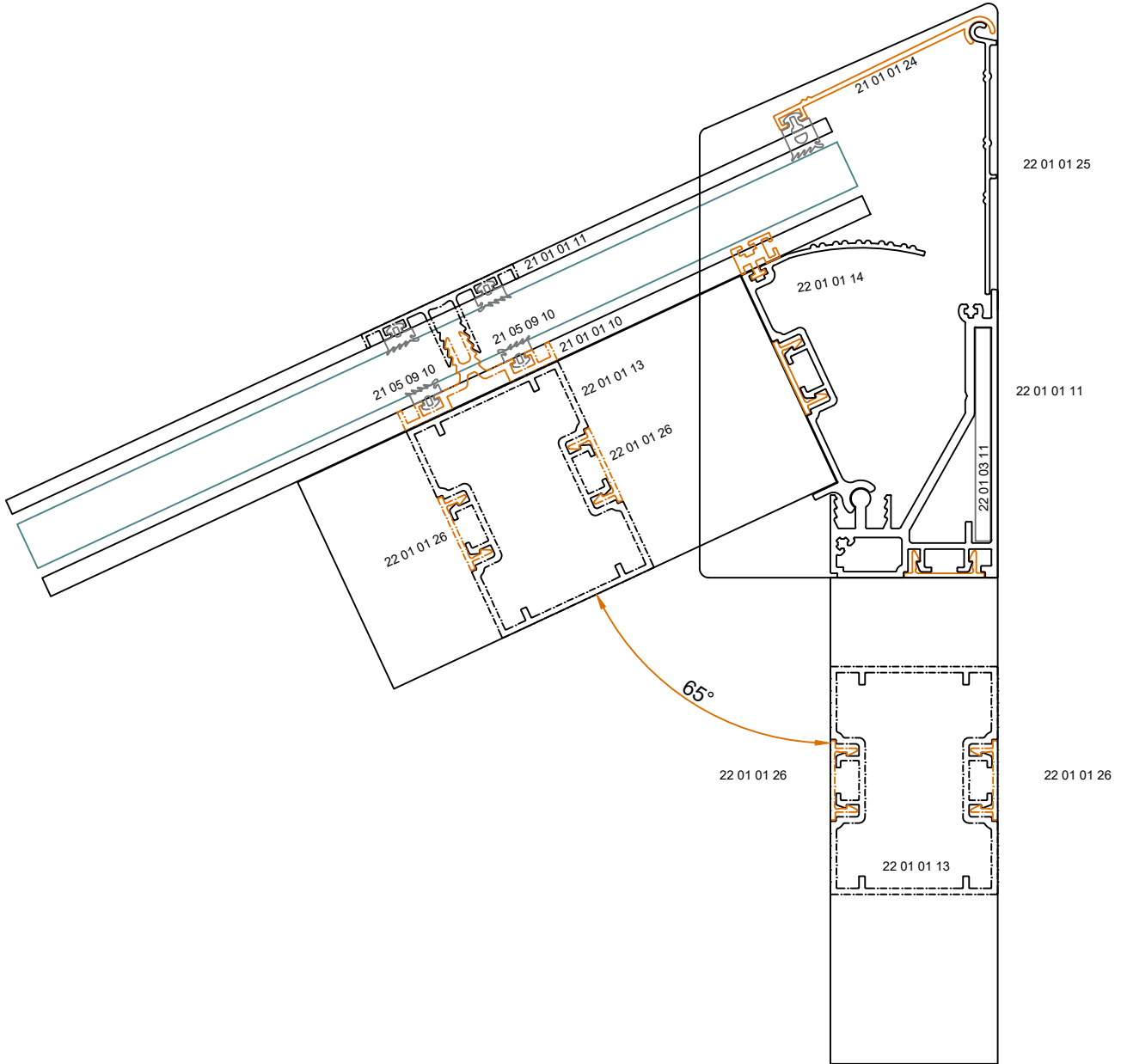

25 degree / 25 derece

# VERA Vertical Section / Dikey Bölüm

Scale / Ölçü : 1/2

## Fixed Veranda System / Sabit Çatı Sistemi

## VERA

16 mm polycarbon plate /  
16 mm polykarbon plaka

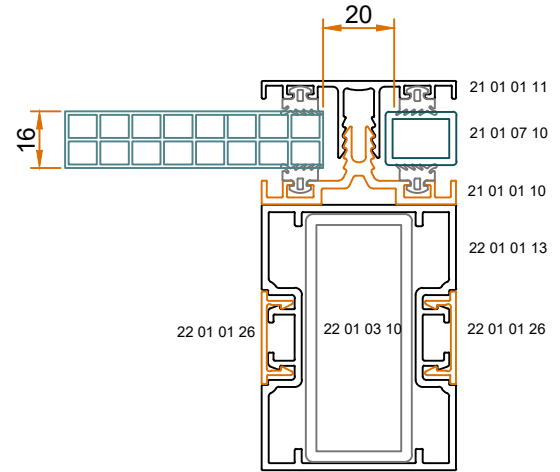
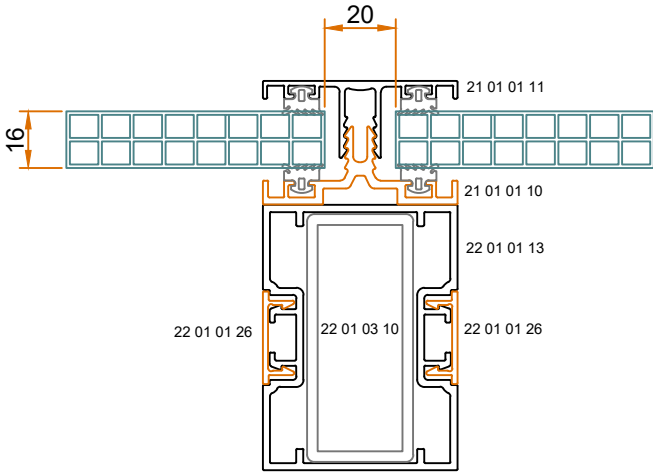

5 mm temp. Solar + 5 mm glass /  
5 mm temp. Solar + 5 mm cam

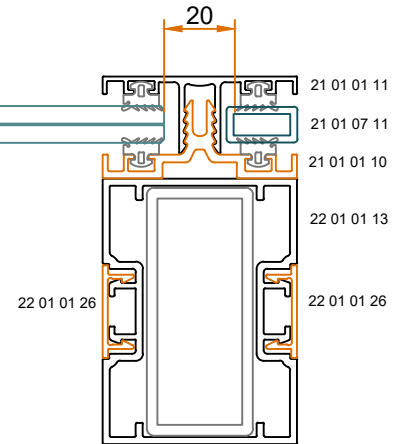
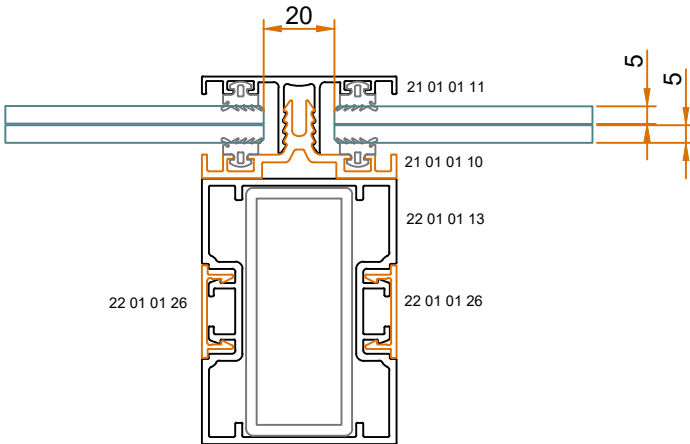

section / kesit

V 004

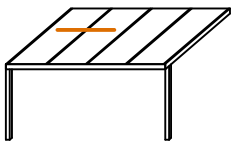

V 004 kesit / section

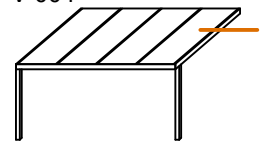



# VERA Upper Section / Üst Bölüm

Scale / Ölçü : 1/2

Fixed Veranda System / Sabit Çatı Sistemi

VERA

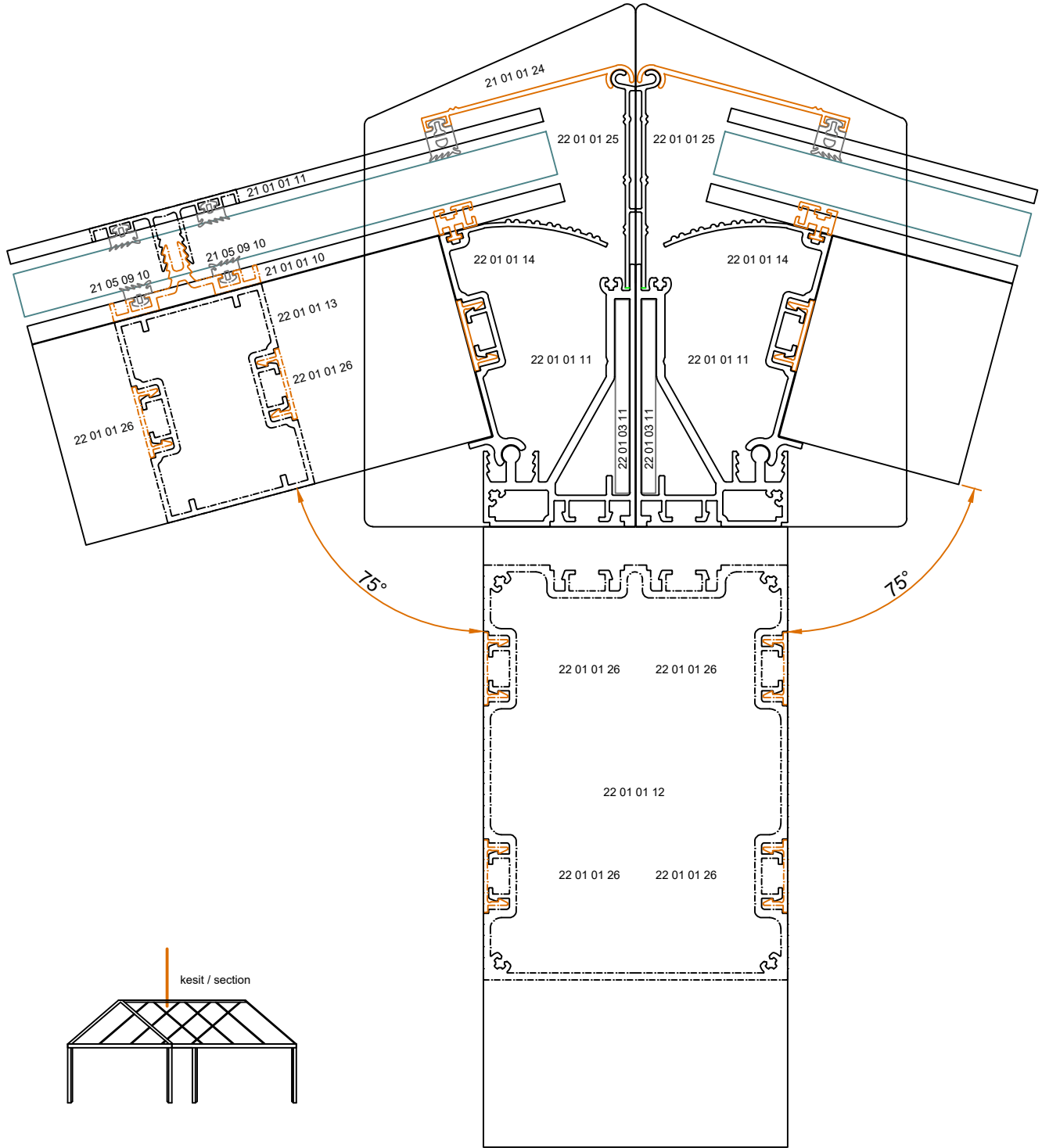

15 degree / 15 derece

# VERA Lower Section / Alt Bölüm



Scale / Ölçü : 1/2

Fixed Veranda System / Sabit Çatı Sistemi

VERA

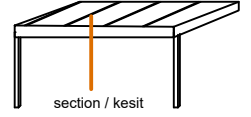

section / kesit

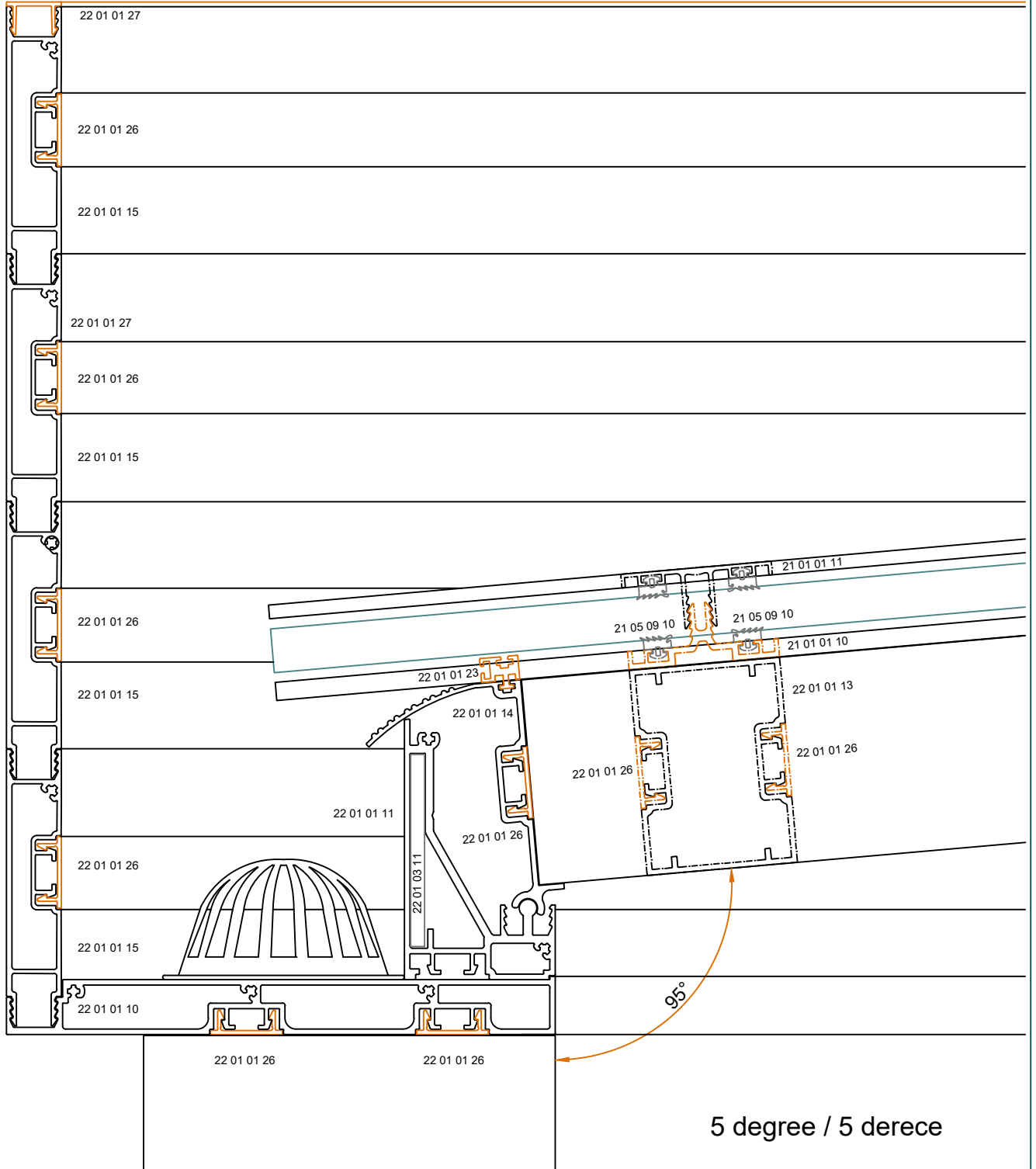

# VERA Upper Section / Üst Bölüm



Scale / Ölçü : 1/2

Fixed Veranda System / Sabit Çatı Sistemi

VERA

section / kesit

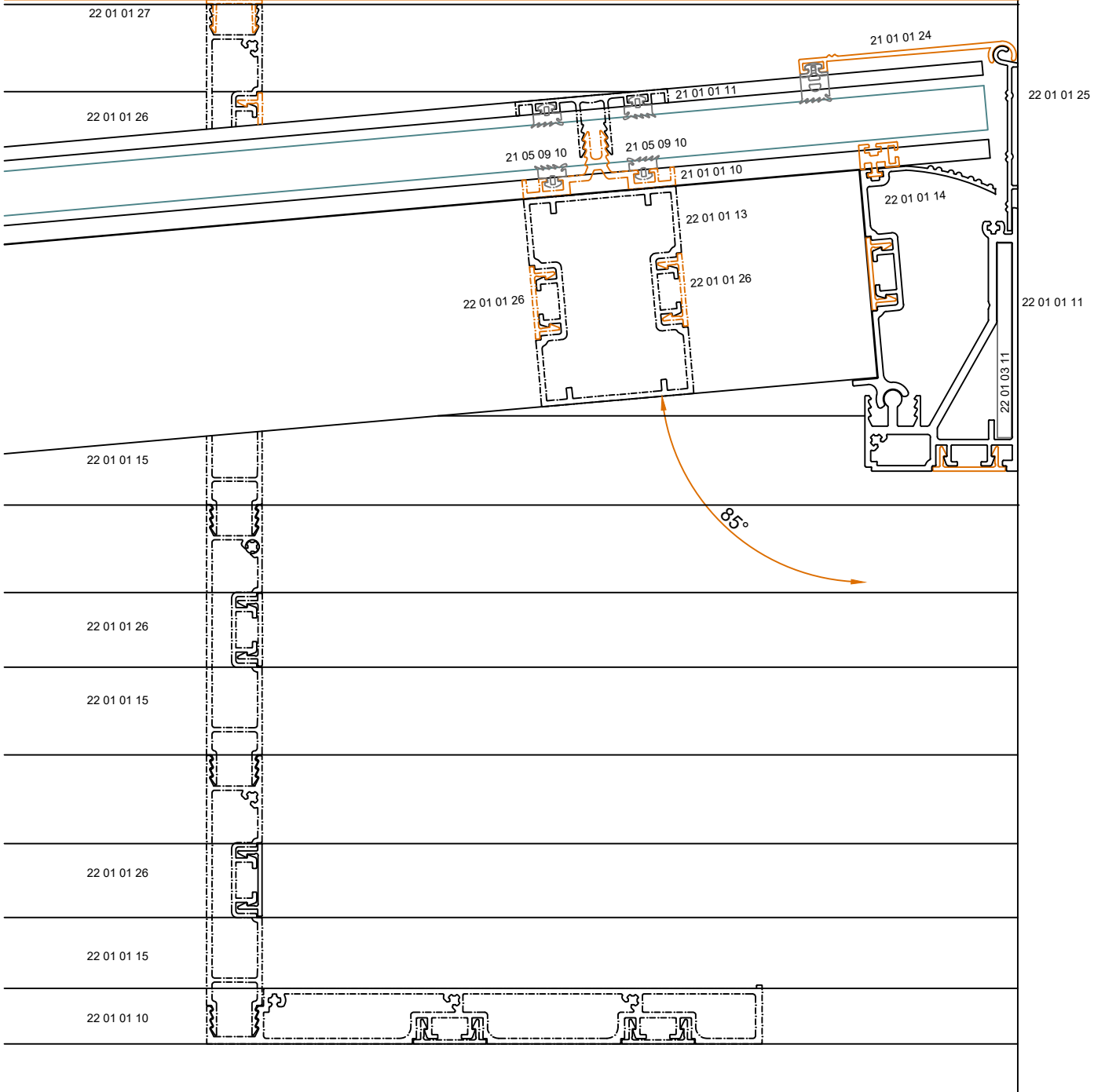
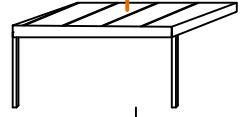

5 degree / 5 derece

# VERA Upper Section / Üst Bölüm



Scale / Ölçü : 1/2

Fixed Veranda System / Sabit Çatı Sistemi

## VERA

section / kesit

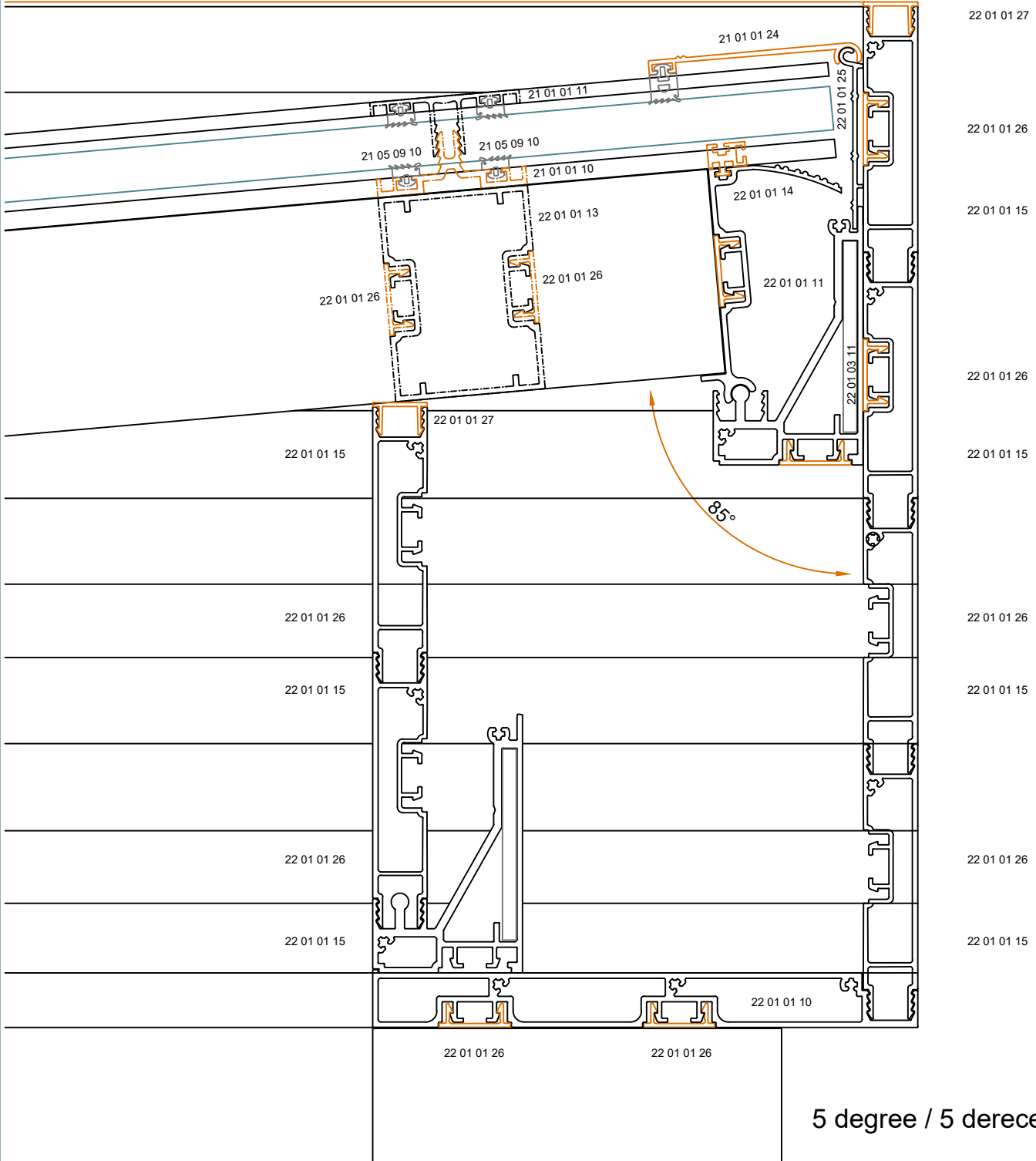
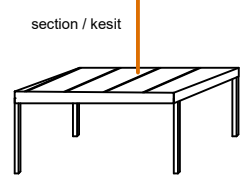





**Istanbul Headquarter**

Fikirtepe Mah. Özbey Cad. No:101, 34720 Kadıköy İstanbul / Turkey

T: +90 216 428 8428

**Dubai Headquarter**

Oud Metha Offices Building, R338 Umm Harair 2, Of:327 Dubai, United Arab Emirates

T: +971 52 839 57760

E: info@aluarc.com

[www.aluarc.com](http://www.aluarc.com)



by Gürkan Building Elements